

1 1/4" Bar Socket – (3/4" Bolt Diameter)

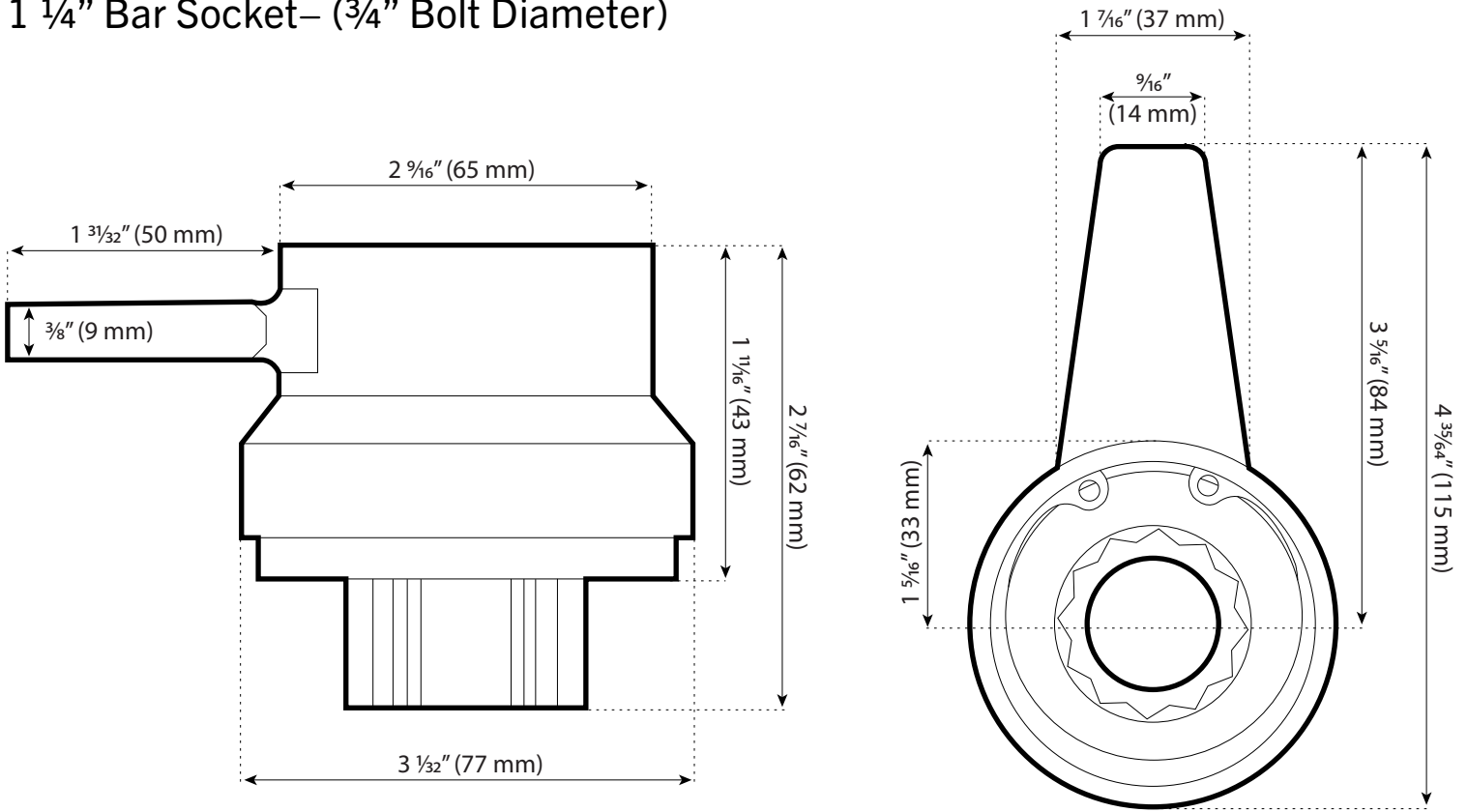

1 7/16" Bar Socket – (7/8" Bolt Diameter)

